



**TWO WAY
NORMALLY CLOSED

HIGH PRESSURE
SOLENOID VALVE**



L20.d

DESCRIPTION

Mechanical Characteristics:

Two Way Normally Closed Pilot Piston Solenoid Valve with spring return. High pressure applications up to 100 Bar. Suitable for gaseous and liquid media compatible with the body and seal materials specified. Vacuum. UREPAN Seals for Liquid CO2 applications. Forged Brass or Nickel Plated Brass body. Stainless steel internal moving parts.
Solenoid can be rotated 360°.
Valve will operate in any position.

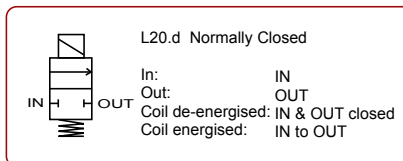

COIL SPECIFICATION:	COIL SERIES: B6E
Insulation Class:	F (155°C) - H (180°C) upon request
Winding Wire Class:	H (180°C)
Coil Housing:	Type 3050 (EExd IIB) or 3070 (EExd IIC)
Protection Class:	Watertight IP67 (EN60529)
Temperature Class:	T6 (ref. T.amb ≤ +40°C). T5 (ref. T.amb ≤ +55°C) upon request
Duty:	Continuous (S.I.) 100% ED
Power Consumption:	AC: 11VA (28VA Inrush. DC 11W)
Voltage Tolerance:	± 10%
Insulation:	> 1000 Mohm
Dielectric Strength:	> 2000 V/1'
Standard Voltages: (Other Voltages Available Upon Request)	12, 24, 48, 110, 220 VAC 50/60 Hz 12, 24, 48, 110, 220 VDC

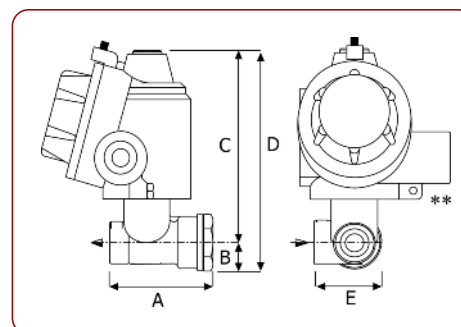

SPECIFICATIONS & DIMENSIONS

MODEL	Orifice mm					Min . /Max. Operating Differential Pressures. BAR.	KV Flow Factor L/min.	Weight Kg	Dimensions mm							
	A	B	C	D	E				Min.	Maximum		A	B	C	D	E
										AC	DC					
L20	87					8.7	0.5	100	60	20	1.2	58	15	107	122	38

ORDER CODES

A	Body	B	Port	C	Seals (fluid temp. min / max)	D	Protection (Codes D & F have been	E	Options
T	Brass	E	3/8" BSP	3	RULON (-10°C to + 120°C)	B	II 1/2 GD EEx-d IIB T6 (-20 to +40°C)		
				8	UREPAN (-10°C to + 90°C)	C	II 1/2 GD EEx-d IIC T6 (-20 to +40°C)		

SAFETY MAINTENANCE AND INSTALLATION INSTRUCTIONS



Solenoid Valve Series: "L", "C", "D", "E", "F", "G" and "H"

The following data is intended exclusively for specialised users only. These person(s) must comply with local and national regulations. This document is for information regarding the installation, assembly, disassembly and authorised maintenance. Such operations must exclusively be performed by authorised technical personnel. The product should be verified and checked that it is suitable for the application, by checking the Solenoid Valve specification against the Application demands (fluids, pressures, temperatures etc.)

Make sure that the type and degree of Solenoid Valve protection, as well as the temperature of the fluid that the valve intercepts are compatible With the degree, the type of protection and the class of temperature required by the classification of the zone, which the valves will be installed.

Use Solenoid Valves only with fluids compatible with the materials of which they are composed: Brass OT58 Uni 5705-65 (Cu 58% Zn 40% Pb 2%). Stainless Steel A X5CrNiMo1712 (AISI 316s) or A X2 CrNiMo1712 (AISI 316Ls) and the type of elastomer used for the seal.

Do not use Solenoid Valves with pressure limits outside that marked on the Identification Plate.

Make sure that the voltage and type of power supply (alterate or continuous) are the same as that marked on the Identification Plate. Make sure the Tolerance of +/- 10% is not exceeded.

Do not energise the Solenoid Valve without the protection cap being completely closed and sealed, the security dowel screwed tight, and the cable Correctly fitted and secured.

Before removing the safety cap, make sure that the Solenoid Valve is not energised.

In the event of Solenoid Coil replacement, use the following procedure using the tools and methods advised by the manufacturer. Use only a Replacement Solenoid Coil supplied by the manufacturer. Verify that the coil has the correct voltage, and is suitable for the model of Solenoid Valve, As indicated on Identification Plate. Ensure that the threaded safety cap and the security dowel are reassembled correctly and that all joints are tight. Ensure that the Electrical Cable is fitted correctly, and that the Explosion Proof Housing is free from the ingress of water.

Do not use the Solenoid Valve Explosion Proof Housing as a lever when mounting the Solenoid Valve on the process pipe line.

INSTALLATION PROCEDURE & METHODS

19 mm hexagon nut.
(present only on some models of solenoid valves)

Security dowel
M4x8 UNI 5927

Rating plate

Threaded cap

A

① ② Safety devices.

Fig. 1

Attention:

For safety Purposes, ensure that the power supply is disconnected. After De-energising, Allow 15 mins. before continuing the next operation

Loosen the security dowel (1), using a 2 mm set screw wrench, turning anticlockwise.

B

Firmly hold the threaded plug (2) and loosen it, by turning anticlockwise. Do not unscrew it completely.

Unscrew completely the threaded plug (3).

Coil

solenoid housing security clip

Terminal board of power supply

Internal ground connecting screw

Power supply wires threaded entry hole.

External ground connecting screw

C

Connect the ground wire to the ground connecting screw (2).

Connect the power supply wires to the terminal board (3) using a (*) 3 mm max. flat screw-driver.

Connect the solenoid valve to the ground using the external ground connecting screw (3).

! Pipe fittings used for cable entry (cable duct, conduit, etc) are NOT supplied by the manufacturer. Should be care of the installer to use fittings of proper diameter and type suitable to secure tightness for the cable used. Pipe fittings (cable duct, conduit, etc) must be ATEX approved for a protection degree equal or greater than the protection degree indicated on the rating plate. Type of thread of the cable entry for the solenoid housing is stamped on the outlet side of the cable entry and it could be: 1/2" Gk, 1/2" NPT, M20x1,5 (ISO M20x1,5).

SOLENOID REPLACEMENT

If fitted unscrew the hexagon nut with a (*) 19 mm wrench turning it anticlockwise.

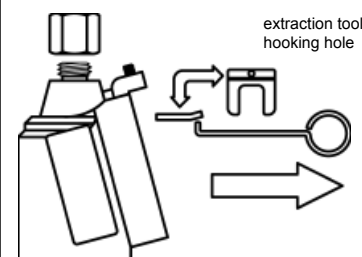

Extract the clip putting the extraction tool (KM/3062) in the hole of the security clip then pull hard to extract the clip.

Extract the solenoid housing and the solenoid from the solenoid valves pulling up. Solenoid housing and solenoid will remain connected to the power supply cable.

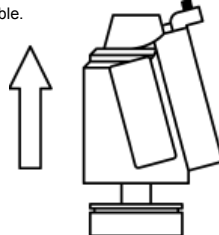

Disconnect power supply and internal ground connecting wires then extract the solenoid housing and the solenoid from the solenoid

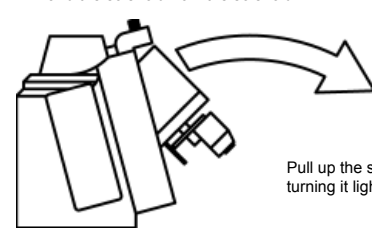

For product safety purpose and conformity with certification, replace the coil only with a coil supplied by the manufacturer suitable for the model stamped on the rating plate. Do not supply the power until the solenoid and the housing have been assembled correctly on the solenoid valve body/pilot.



NADI srl
**PRODUCT CODE
 IDENTIFICATION**

**SOLENOID VALVES
 PNEUMATIC VALVES**

VALVE DE-CODING TABLE

Model (10 or 11 digits)

L 0 2 T 1 8 C 0 P X

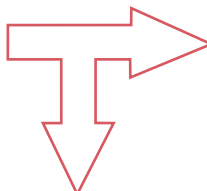

MARKING EXAMPLE

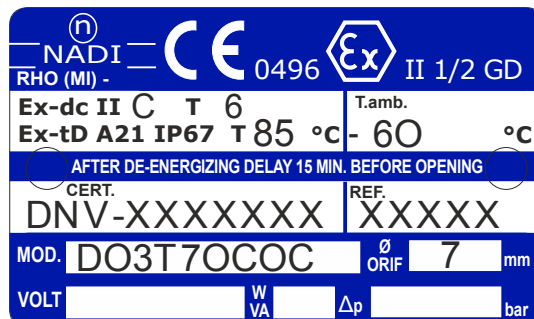

VALVE TYPE	
M	Air Operated Valve
L	2 Way Solenoid Valve
C	3 Way Solenoid Valve
D	5 Way Solenoid Valve
E	Man. Reset 2 Way S.valve
F	Man. Reset 3 Way S.valve
G	Man. Reset 5 Way Sol. Valve
V	Special Manufacture

GROUP NUMBER	
From 0 to 99	

BODY MATERIAL	
T	Brass / Bronze
H	303/304 Stainless Steel
I	316 Stainless Steel
L	Light Alloy
C	Cast Iron
D	Ductile Iron
A	Aluminium
P	Plastic
Z	Other

ORIFICE DIAMETER MM

PORT CONNECTION SIZE. THREADED.					
A	1/8" BSP	H	3/4" BSP	X	M5
B	1/8" NPT	I	3/4" NPT	Y	M8
C	1/4" BSP	L	1" BSP	Q	2 1/2" BSP
D	1/4" NPT	M	1" NPT	R	3" BSP
E	3/8" BSP	N	1 1/4" BSP	S	4" BSP
T	3/8" NPT	O	1 1/2" BSP	U	collector
F	1/2" BSP	V	1 1/2" NPT	Z	other
G	1/2" NPT	W	2" NPT		

FLANGED PORT. RDV Code				NADI Code
FL	-	A	PN16	Z (UNI-2282)
FL	-	B	PN25	
FL	-	C	ANSI 150	Y
FL	-	D	ANSI 300	X
FL	-	E	JIS	
FL	-	F	PN10	
FL	-	G	PN40	

Example:

FL3A = 3" PN16
 FL34A = 3/4" PN16

OPTIONS	
W	Manual Override. Push Button
X	Manual Override. 1/4 Turn
Y	Transmission Pin
/AP	High Pressure version
/SG	Degreased for Oxygen
/LT	ATEX +60C Ambient
/C	Anti-noise Condenser
/V	Varistor
/LC	Low Consumption Coil
/H	Class H Coil Winding

SOLENOID PROTECTION	
A	EExia (Intrinsically Safe)
B	Ex-dc IIB IP67
C	Ex-dc IIC IP67
P	IP65 (Safe Area)
S	IP67 Housing (Safe Area)

SEALS	
0	NBR (Buna N)
1	VITON
2	UREPAN
3	PTFE / RULON
4	Metallic
5	Neoprene
6	EPDM
7	HNBR (-45°C)
8	PE
9	NBR (Buna N 60 sh.)
10	TEFLON
11	PE (Nylon)
12	Silicone