





## Aluminum alloy 3/4"-1"NPT Pressure Regulator – R serie

Regolatore di pressione da 3/4" - 1"NPT in lega di alluminio – serie R

- Suitable for automation equipment to onshore, offshore, pharmaceutical, medical and food applications
- Full material traceability
- Excellent stability and repeatability
- Accurate adjustment and high flow capacity
- ATEX 2014/34/UE - II2GD c IICT6 X $\text{Ex}$  / IP66
-  approved / SIL 3 - IEC 61508 

- Adatto per automazione in applicazioni marine, petrolchimiche, farmaceutiche, medicali e alimentari
- Completa rintracciabilità dei materiali
- Eccellente stabilità e ripetibilità
- Precise regolazioni ed elevate portate
- ATEX 2014/34/UE - II2GD c IICT6 X $\text{Ex}$  / IP66
- Approvato  / SIL 3 - IEC 61508 

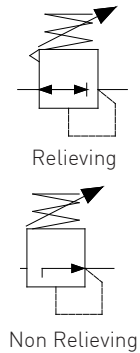

Media / Fluido	Air, inert gases, sweet and sour gases, clean water
Port thread / Connessioni	3/4"-1" NPT
Gauge Connection Connessione manometro	1/4"NPT (1/8"NPT option)
Max inlet pressure / Pressione massima di ingresso	25bar
Relieving/ Scarico sovrappressioni	Standard
Flow rate (@10bar inlet, 6bar regulated, delta P=1bar) / Portata	11500dm <sup>3</sup> /min Cv=11.5
Working temperature / Temperatura di esercizio	-20°C up to 80°C (NBR); -25°C up to 90°C (FKM); -40°C up to 80°C (EPDM) *
Regulated pressure Pressioni regolate	0/2, 0/4, 0/8, 0/10bar

Air supply must be dry enough to avoid ice formation at temperatures below +2°C (+35°F).

\*Special version available for -55°C up to 90°C

It provides excellent regulation and for a wide range of applications. Rugged and corrosion-resistant – made of aluminum alloy and SS AISI304/316 / Permette un'accurata regolazione per una vasta gamma di applicazioni. Robusto e resistente alla corrosione – Costruito lega di alluminio ed AISI316

BUILDING MATERIALS	Materiali costruttivi
Body, bonnet, bowl in tropicalized aluminum alloy, internals in stainless steel	Corpo, coperchio, piastra inferiore in lega di alluminio tropicalizzata, particolari interni in acciaio inossidabile
Adjustment screw, lock and panel nuts, fixing screws AISI316 stainless steel or galvanized steel	Vite di regolazione, dadi di bloccaggio e pannello, viti di fissaggio in acciaio inossidabile od acciaio galvanizzato
Diaphragm and valve assembly in elastomer and AISI316 stainless steel	Assieme diaframma ed assieme valvola in elastomero ed acciaio inossidabile AISI316
Valve spring & adjustment spring AISI316 stainless steel	Molle valvola e di regolazione in acciaio inossidabile AISI316
Seals in elastomer	Guarnizioni in elastomero

**Overall dimension**

Dimensioni di ingombro

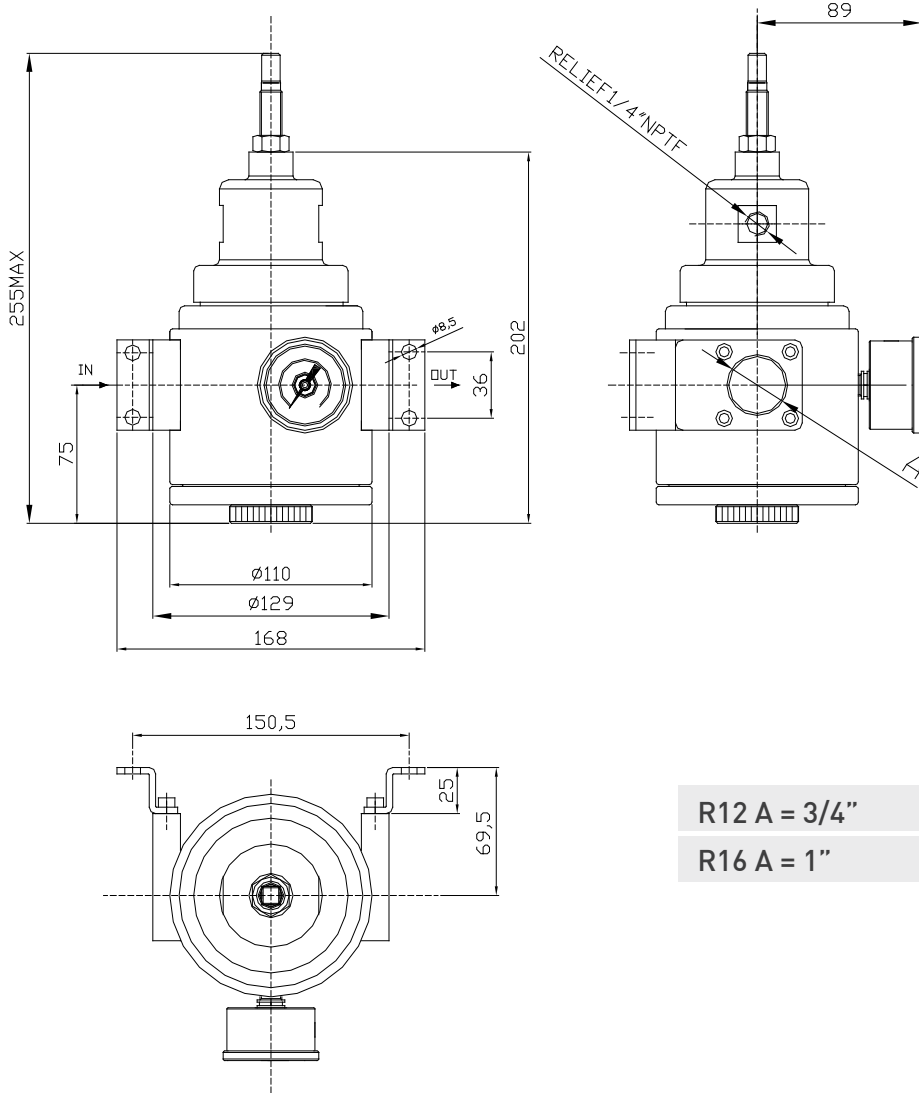

R12 A = 3/4"  
R16 A = 1"

**Accessories and repair kit**

Accessori e ricambi

Maintenance kit / Kit manutenzione	Items R-16-K-XAL-** [3/4"; 1"]
Pressure gauge DN40mm, SS case, Bar+psi+kpa range / Manometro DN40mm, cassa inox, scala Bar+psi+kpa	0-2bar MBSNP4S2PN3S 0-4bar MBSNP4S2PN05 0-10bar MBSNP4S2PN07
Bracket and screws / Staffa e Viti	SQ-FR16

\*\* Refers to seals type:  
FK→FKM NB→NBR LT→EPDM FL→Low temperature compound HN→HNBR

# Ordering information

## Come ordinare

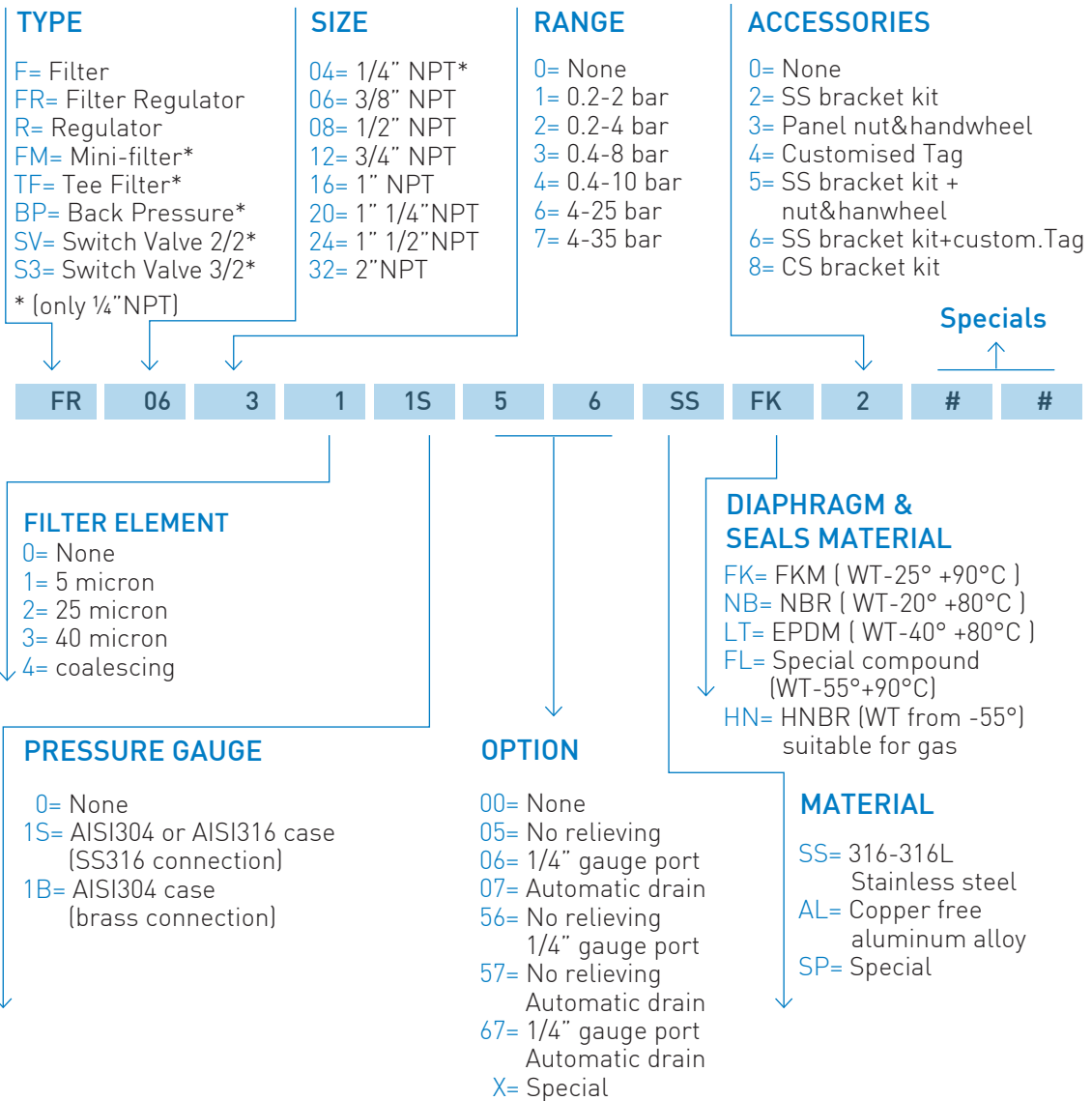

### CODE EXAMPLES

FR 06 3 3 1S 0 7 SS FK 2

**3/8"NPT, SS316, 0 to 8 bar range, filter regulator, with 40 micron filtering element, relieving, SS pressure gauge, automatic drain, ss bracket kit and FKM diaphragm & seals**  
 Filtro regolatore da 3/8"NPT in AISI316, range regolato 0/8 bar, elemento filtrante da 40 micron, manometro tutto inox, relieving, scarico condensa automatico, staffa inox, diaframma e tenute in FKM

FR 06 3 1 00 0 0 SS FK 0

**3/8"NPT, SS316, 0 to 8 bar range, filter regulator, with 5 micron filtering element, relieving and FKM diaphragm & seals**  
 Filtro regolatore da 3/8"NPT in AISI316, range regolato 0/8 bar, elemento filtrante da 5 micron, relieving, diaframma e tenute in FKM

